

Sluice gates for Slurry-Handling

Stainless steel or galvanized

405BG

Lever arm for sluice gate galv.

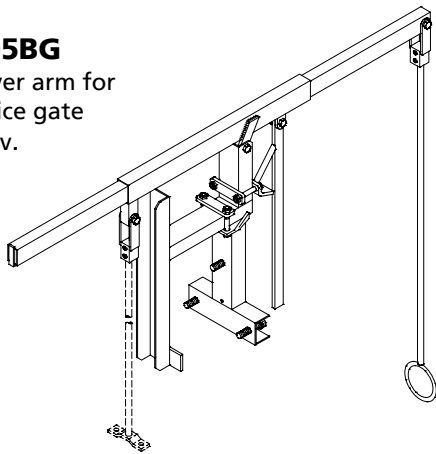

405MR315

Sluice gate with muff
ø315 mm PVC
St. steel
Culvert in sluice gaet ø309 mm

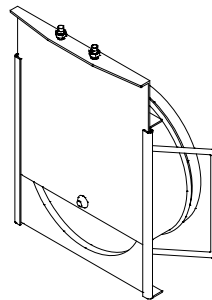

401FR50

401FR60

Sluice gate with flange
incl. bolts
St. steel

Outer size (h x w)	Inner size (h x w)
69 x 72 cm	50 x 47 cm
79 x 84 cm	60 x 60 cm

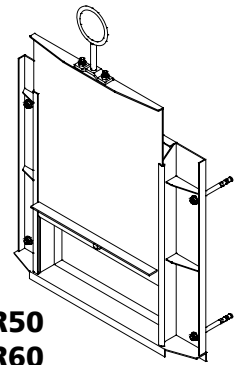

405IR

Guide fittings for concrete
St. steel

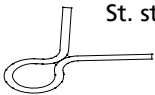

405PR

Guide fitting for bolting on

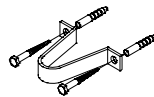

405R16/2

405R16/3

405R16/4

405R16/5

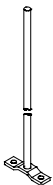

401L

Hook for sluice gate

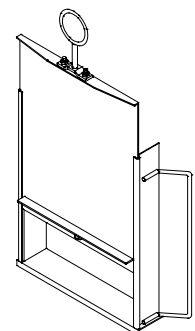
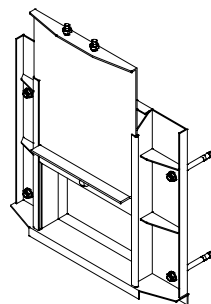
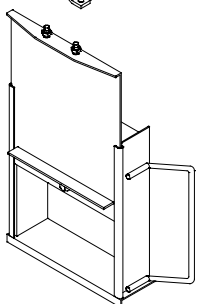

405R33

Sluice gate with frame
for concreting

St. steel

Outer size (h x w)	Inner size (h x w)
43 x 48 cm	32 x 31 cm

405FR33

407FR33

Sluice gate with
large flange
St. steel

Outer size (h x w)	Inner size (h x w)
51 x 55 cm	32 x 31 cm
64 x 72 cm	32 x 31 cm

401R50

401R60

Sluice gate with frame
for concreting
St. steel

Outer size (h x w)	Inner size (h x w)
66 x 60 cm	50 x 47 cm
78 x 72 cm	60 x 60 cm

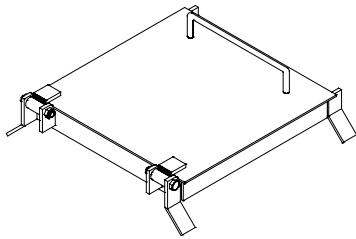

400G40
400HR40

Drop gate with hinges for channels
St. steel – galv.
Outer size Inner size
48 x 47 cm 40 x 40 cm

400L
Lifting hook

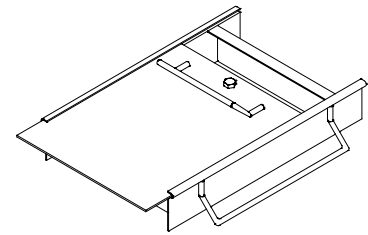

400R40

Drop gate
St. steel
Outer size (w x l) Inner size (w x l)
60 x 49 cm 40 x 40 cm

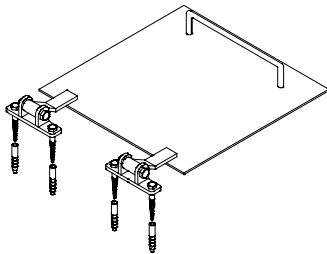

400PR40

Drop gate
St. steel
Outer size
41,5 x 41,5 cm

402L
Lifting hook

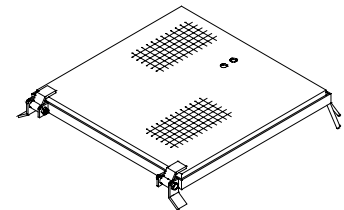
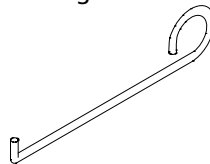

402CG

Drop gate with gully trap
for handling or drain
Galv.
Outer size Inner size
65 x 65 cm 58 x 58 cm

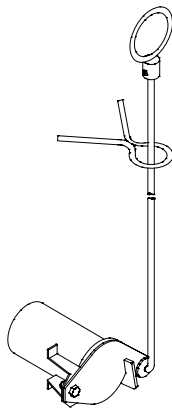

406R110
406R160

Stop tap for PVC flushing
pipe
St. steel
Size
for 110 mm PVC
for 160 mm PVC

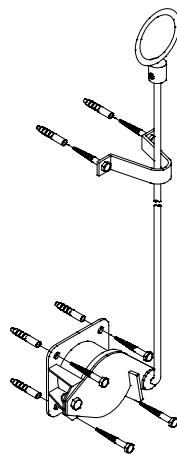

406FR110
406FR160

Stop tap for PVC bottom
flushing pipe
St. steel
Size
for 110 mm PVC for 110 mm PVC
for 160 mm PVC

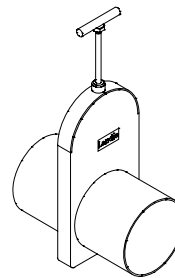

7614000
7614001
7614004

Valve with handle for
PVC pipe for concreting
St. steel
Size
for 160 mm PVC
for 200 mm PVC

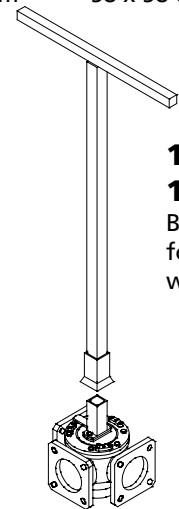

168G1
168G2
Box key
for two-
way tap

7603135
7603146
7603157

Two-way tap with
fitting for box key

The text and the technical data given must not be reproduced partly or completely without permission from Landia A/S.
We reserve the right to make technical alterations

201073GB-150404

Head office: **Landia A/S**
Industrivej 2
DK- 6940 Lem St.
Tel.: 97 34 12 44
Fax: 97 34 16 98
e-mail: info@landia.dk
www.landia.dk

UK-Branch: **Landia (UK) Ltd.**
Waymills Industrial Estate
Whitchurch, Shropshire SY13 1TT
Tel.: 01948 661 200
Fax: 01948 661 201
e-mail: info@landia.co.uk
www.landia.co.uk